

Index Plungers · with mounting flange

22120.0967



Product Description

Index plungers are used for indexing bores.
For fixing onto thin walled parts.
The small dimensions are a feature of these index plungers.

Material

Flange

- Zinc die-cast, zinc-plated by galvanization

Locking pin

- Stainless steel 1.4305, nickel-plated

Knob

- Thermoplastic PA 6, black, dull

Operation

When using locking index plungers the knob is pulled out and turned 90°.

More information

Notes

Knob not removable.

Further products

- Locating Bushings, for index bolts and index plungers

Drawing

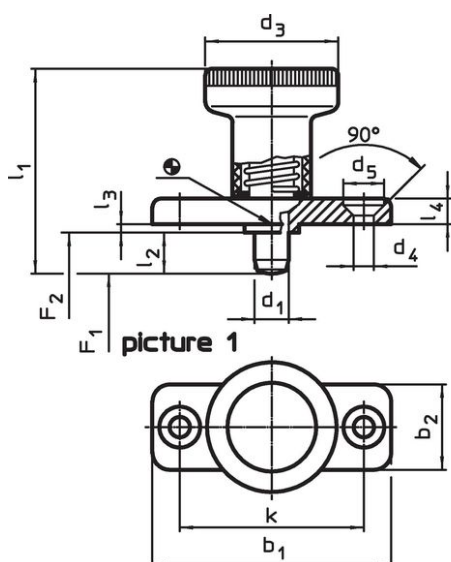

picture 1

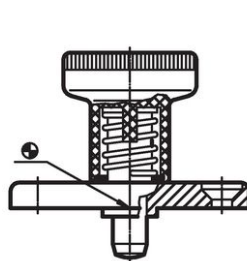

picture 2 with locking

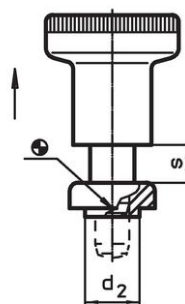

Order information

Dimensions													Spring load ¹⁾		Temperature		Weight [g]	Art. No. ²⁾
d ₁	l ₂	b ₁	b ₂	d ₂	d ₃	d ₄	d ₅	k	l ₁	l ₃	l ₄	s	F ₁	F ₂	min.	max.		
-0.02				-0.02						-0.15				~	~			
-0.05				-0.1										[N]	[N]	[°C]	[°C]	
without locking – picture 1, Stainless steel																		
6	14	40	18	10	25	4.3	8.3	30	45	2.5	4.5	6	8.5	22	-30	80	37	22120.0967

¹⁾ statistical average value

²⁾ Locking pin is not completely retractable

Application example



Compliance

RoHS compliant

Compliant according to Directive 2011/65/EU and Directive 2015/863.

Does not contain SVHC substances

No SVHC substances with more than 0.1% w/w contained - SVHC list [REACH] as of 23.01.2024.

Does not contain Proposition 65 substances

No Proposition 65 substances included.
<https://www.P65Warnings.ca.gov/>

Free from Conflict Minerals

This product does not contain any substances designated as "conflict minerals" such as tantalum, tin, gold or tungsten from the Democratic Republic of Congo or adjacent countries.