

Index Plungers • threadless, weldable

22120.0808



Product Description

Index plungers are used for indexing bores.

Material

Body

- Steel, blackened, weldable

Locking pin

- Steel, hardened

Knob

- Thermoplastic PA 6, black

Assembly

Attached by welding or glueing.

More information

Notes

Knob not removable.

Further products

- Locating Bushings, for index bolts and index plungers

Drawing

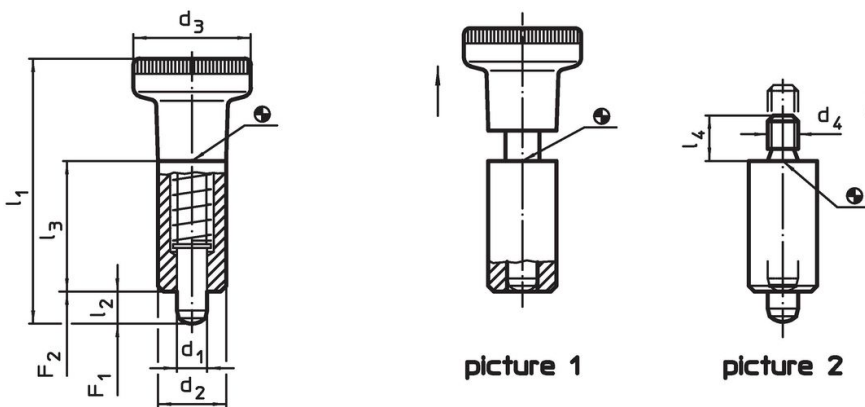

Order information

Dimensions			Spring load ¹⁾		Temperature		Weight [g]	Art. No.			
d ₁	d ₂	d ₃	F ₁	F ₂	min.	max.					
-0.02 -0.05	h9		~	~							
[mm]			[N]		[°C]		[g]				
with knob – picture 1											
8	18	31	69	8	34	12	31	-30	80	84	22120.0808

¹⁾ statistical average value

Application example



Compliance

RoHS compliant

Contains lead - compliant according to exceptions 6a / 6b / 6c.

Contains SVHC substances >0,1% w/w

Contains lead - SVHC list [REACH] as of 23.01.2024.

Contains Proposition 65 substances



Lead can cause cancer and reproductive harm from exposure
<https://www.P65Warnings.ca.gov/>

Free from Conflict Minerals

This product does not contain any substances designated as "conflict minerals" such as tantalum, tin, gold or tungsten from the Democratic Republic of Congo or adjacent countries.