

Index Plungers · simple finish

22120.0788



Product Description

Application is limited to cases not requiring a precise positioning.
Simple finish with very small dimensions.

Material

Body

- Stainless steel 1.4305

Locking pin

- Stainless steel 1.4305

Knob

- Thermoplastic PA 6, black, dull

Operation

When using locking index plungers, the knob is pulled-out, turned 90° and secured by a notched catch (when locking pin should not overhang).

More information

Notes

Lock nuts have to be purchased separately.
Knob not removable.

Further products

- Locating Bushings, for index bolts and index plungers

Drawing

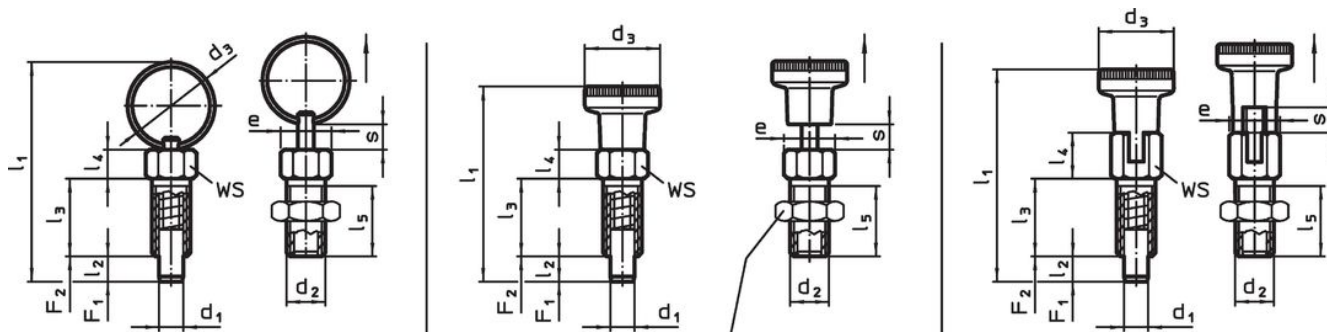

lock nut
22120.0704 - .0708 (Steel)
22120.0714 - .0718 (Stainless steel)

picture 1

picture 2

picture 3

Order information

Dimensions										WS	Tightening torque max.	Spring load ¹⁾		Temperature		Weight [g]	Art. No.
d ₁	d ₂	d ₃	e	l ₁	l ₂ min.	l ₃	l ₄	l ₅	s min.			F ₁ ~	F ₂ ~	min.	max.		
[mm]										[mm]	[Nm]	[N]		[°C]		[g]	
with knob, without locking – picture 2, Stainless steel																	
8	M12	21	13.8	59	8	24	9	20.5	8	12	20	6	22	-30	80	31	22120.0788

¹⁾ statistical average value

Accessories

	Dimensions d ₂ [mm]	Wrench size [mm]	Weight [g]	Art. No.
Stainless steel				
	M12	18	7.6	22120.0718

Application example



Compliance

RoHS compliant

Compliant according to Directive 2011/65/EU and Directive 2015/863.

Does not contain SVHC substances

No SVHC substances with more than 0.1% w/w contained - SVHC list [REACH] as of 23.01.2024.

Does not contain Proposition 65 substances

No Proposition 65 substances included.

<https://www.P65Warnings.ca.gov/>

Free from Conflict Minerals

This product does not contain any substances designated as "conflict minerals" such as tantalum, tin, gold or tungsten from the Democratic Republic of Congo or adjacent countries.