

Distance Collars • for index plungers

22120.0632



Product Description

Distance collars adapt the thread of index plungers to different thread reaches.

Material

- Stainless steel 1.4305

Drawing



EH 22110.

EH 22120.

mini indexes

index plunger short

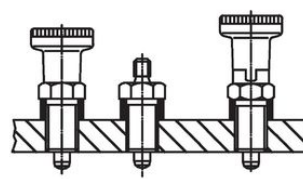
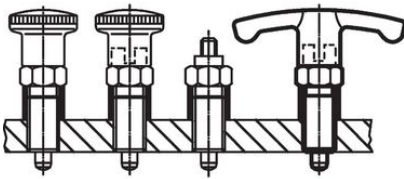

picture 1

picture 2

picture 3

picture 4

Order information

Dimensions			For index plungers size	For finish picture	max.		Art. No.
d ₁	l	d ₂					
H12	±0.1	-0.1					
	[mm]		[mm]		[°C]	[g]	
8	2	10	M8	1/2	250	0.4	22120.0632

Application example

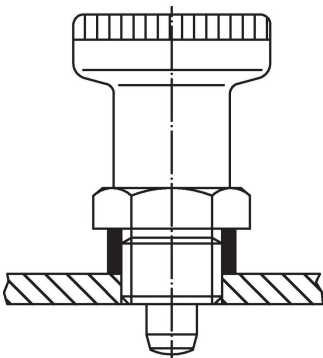



Compliance

RoHS compliant

Compliant according to Directive 2011/65/EU and Directive 2015/863.

Does not contain SVHC substances

No SVHC substances with more than 0.1% w/w contained - SVHC list [REACH] as of 23.01.2024.

Does not contain Proposition 65 substances

No Proposition 65 substances included.
<https://www.P65Warnings.ca.gov/>

Free from Conflict Minerals

This product does not contain any substances designated as "conflict minerals" such as tantalum, tin, gold or tungsten from the Democratic Republic of Congo or adjacent countries.