

## Mounting Blocks · for index bolts and index plungers

22120.0548



### Product Description

Assembly support and extended applications for index bolts.  
Also usable for index plungers size 6, 8 and 10.

### Material

#### Grub Screw

- Stainless steel, with brass pad

#### Body

- Stainless steel 1.4305

### Drawing

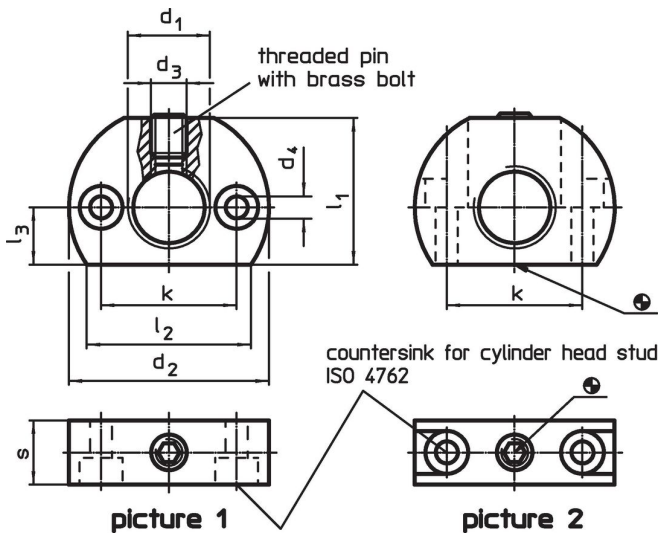

### Order information

Dimensions									max. [°C]	[g]	Art. No.
d <sub>1</sub>	d <sub>2</sub>	d <sub>3</sub>	d <sub>4</sub>	k ±0.1	l <sub>1</sub>	l <sub>2</sub> ~	l <sub>3</sub>	s			
mounting hole vertical to index bolt and index plunger – picture 2, Stainless steel											
M16 x 1,5	46	M8	5.5	32	33	38	13	15	250	106	22120.0548

## Application example



## Compliance

### RoHS compliant

Compliant according to Directive 2011/65/EU and Directive 2015/863.

### Does not contain SVHC substances

No SVHC substances with more than 0.1% w/w contained - SVHC list [REACH] as of 23.01.2024.

### Does not contain Proposition 65 substances

No Proposition 65 substances included.  
<https://www.P65Warnings.ca.gov/>

### Free from Conflict Minerals

This product does not contain any substances designated as "conflict minerals" such as tantalum, tin, gold or tungsten from the Democratic Republic of Congo or adjacent countries.