

## Index Bolts 22120.0363



### Product Description

Index bolts are used for indexing purposes. Plastic cover for grip allows better handling.

#### Material

##### Body

- Stainless steel 1.4305

##### Locking pin

- Stainless steel 1.4305, nickel-plated

##### Catch

- Dry powdered metal 1.4404

##### Plastic cap

- Thermoplastic, black, dull

#### Operation

By turning the index bolt 180° the locking pin will be pulled-in and secured by a notched catch (when locking pin should not overhang).

#### More information

#### Notes

Lock nuts have to be purchased separately.

#### Further products

- Mounting Blocks, for index bolts and index plungers, die-cast
- Locating Bushings, for index bolts and index plungers
- Mounting Blocks, for index bolts and index plungers

### Drawing

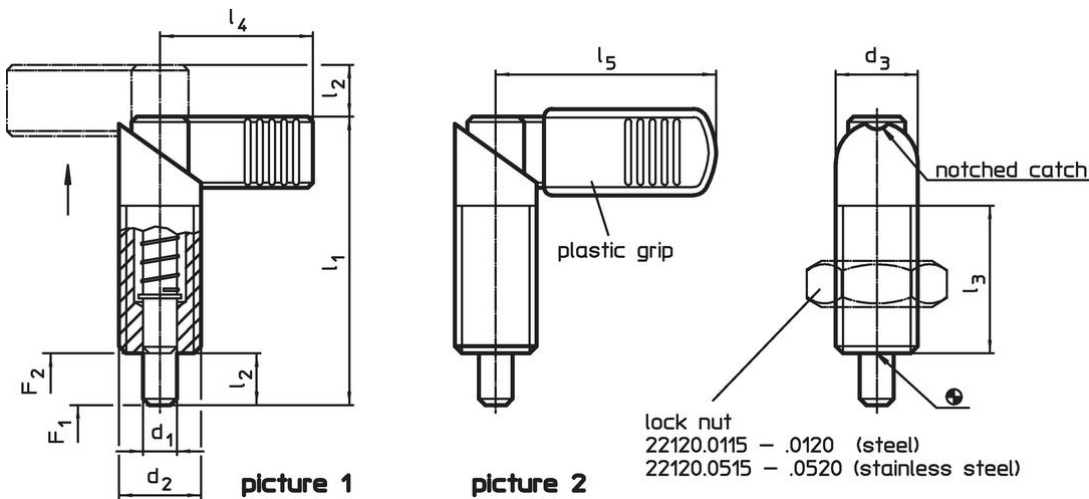



### Order information

Dimensions							Spring load <sup>1)</sup>		Temperature		Weight	Art. No.
d <sub>1</sub>	d <sub>2</sub>	d <sub>3</sub>	l <sub>1</sub>	l <sub>2</sub>	l <sub>3</sub>	l <sub>5</sub>	F <sub>1</sub>	F <sub>2</sub>	min.	max.	[g]	
-0.02							~	~				
-0.04												
[mm]												
[N]												
[°C]												
[g]												
with plastic cover for grip – picture 2, Stainless steel												
5	M12 x 1,5	12	47	8	26	32	8.5	19.5	-30	80	30	22120.0363

<sup>1)</sup> statistical average value

## Accessories

	Dimensions d <sub>2</sub> [mm]	Wrench size [mm]	 [g]	Art. No.
<b>Lock nuts ISO 8675 (DIN 439), Stainless steel</b>				
	M12 x 1,5	18	7.5	22120.0516

## Compliance

### RoHS compliant

Compliant according to Directive 2011/65/EU and Directive 2015/863.

### Does not contain SVHC substances

No SVHC substances with more than 0.1% w/w contained - SVHC list [REACH] as of 23.01.2024.

### Does not contain Proposition 65 substances

No Proposition 65 substances included.

<https://www.P65Warnings.ca.gov/>

### Free from Conflict Minerals

This product does not contain any substances designated as "conflict minerals" such as tantalum, tin, gold or tungsten from the Democratic Republic of Congo or adjacent countries.