

Index Plungers · without hexagon collar

22120.0045



Product Description

Index plungers are used for indexing bores.

Material

Body

- Free cutting steel, blackened

Locking pin

- Steel, hardened

Knob

- Thermoplastic PA 6, black

Assembly

Suitable mounting tools are available.

More information

Notes

Knob not removable.
Lock nuts have to be purchased separately.

Further products

- Mounting Blocks, for index bolts and index plungers, die-cast
- Locating Bushings, for index bolts and index plungers
- Distance Collars, for index plungers

Drawing

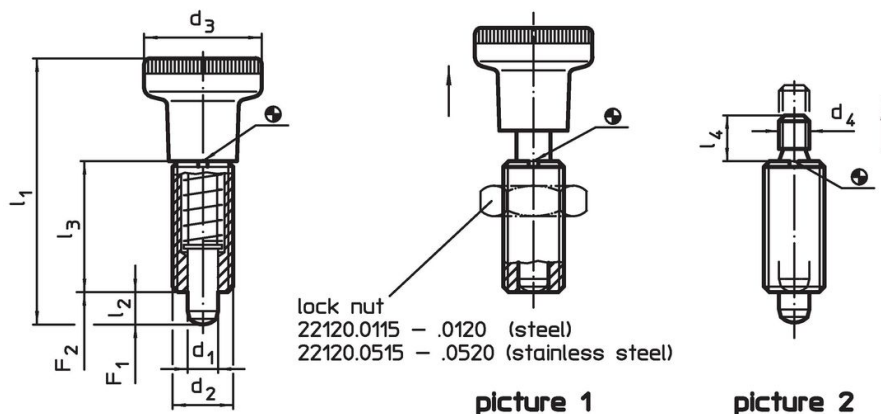



Order information

Dimensions						Spring load ¹⁾		Temperature		Weight [g]	Art. No.
d ₁	d ₂	d ₃	l ₁	l ₂	l ₃	F ₁	F ₂	min.	max.		
-0.02			~	min.		~	~				
-0.05											
[mm]											
											[N]
											[°C]
											[g]
with knob – picture 1, Free cutting steel											
5	M10 x 1	21	45	5	22	6	14	-30	80	17	22120.0045

¹⁾ statistical average value

Accessories

	Dimensions d ₂ [mm]	Wrench size [mm]	 [g]	Art. No.
Lock nuts ISO 8675 (DIN 439), Steel				
	M10 x 1	16	5.2	22120.0115
assembly tool, Steel				
	M10 x 1	-	9.3	22120.0955

Application example



Compliance

RoHS compliant

Contains lead - compliant according to exceptions 6a / 6b / 6c.

Contains SVHC substances >0,1% w/w

Contains lead - SVHC list [REACH] as of 23.01.2024.

Contains Proposition 65 substances



Lead can cause cancer and reproductive harm from exposure
<https://www.P65Warnings.ca.gov/>

Free from Conflict Minerals

This product does not contain any substances designated as "conflict minerals" such as tantalum, tin, gold or tungsten from the Democratic Republic of Congo or adjacent countries.