

## Mounting Blocks · for index bolts and index plungers, die-cast

22110.0510



### Product Description

Assembly support and extended applications for index bolts and index plungers. Also to be used as a seat for locating bushings EH 22110.

### Material

#### Grub Screw

- Steel, blackened, with brass pad

#### Body

- Zinc die-cast, plastic coated, black

### Assembly

Index plunger must be assembled in hole  $d_1$  on countersink side.

### More information

### Further products

- Positioning Bushings, for index bolts and index plungers

### Drawing

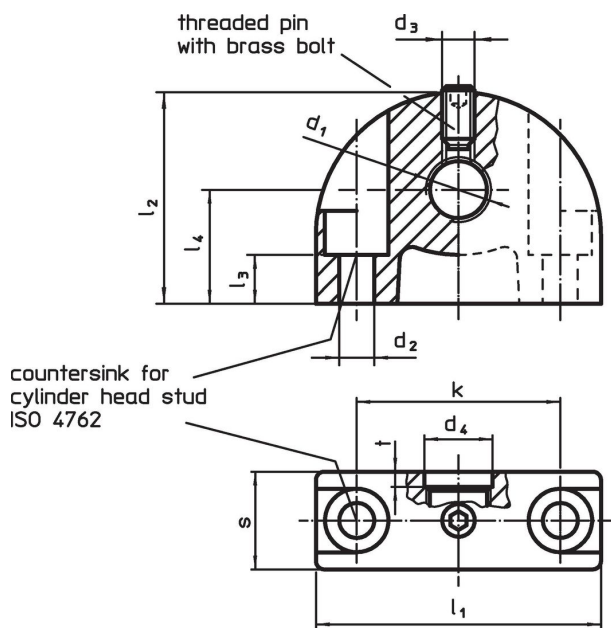

### Order information

Dimensions											max. [°C]	[g]	Art. No.		
$d_1$	$d_2$	$d_3$	$d_4$	k	$l_1$	$l_2$	$l_3$	$l_4$	s	t					
mounting hole vertical to index bolt and index plunger															
M10	4.3	M4	10.2	25	35	26	6	14	12	2	100	38	22110.0510		

## Application example



## Compliance

### RoHS compliant

Contains lead - compliant according to exceptions 6a / 6b / 6c.

### Contains SVHC substances >0,1% w/w

Contains lead - SVHC list [REACH] as of 23.01.2024.

### Contains Proposition 65 substances



Lead can cause cancer and reproductive harm from exposure  
<https://www.P65Warnings.ca.gov/>

### Free from Conflict Minerals

This product does not contain any substances designated as "conflict minerals" such as tantalum, tin, gold or tungsten from the Democratic Republic of Congo or adjacent countries.