

Index Plungers · with mounting flange, horizontal

22110.0305



Product Description

Index plungers are used for indexing bores.

Material

Housing

- Zinc die-cast, plastic coated, black

Locking pin

- Stainless steel 1.4305

Pull-ring

- Stainless steel 1.4310

Assembly

Assembly by means of washers ISO 7092.

Operation

When using locking index plungers, the knob is pulled-out, turned 90° and secured by a notched catch (when locking pin should not overhang).

More information

Notes

Knob not removable.

Drawing

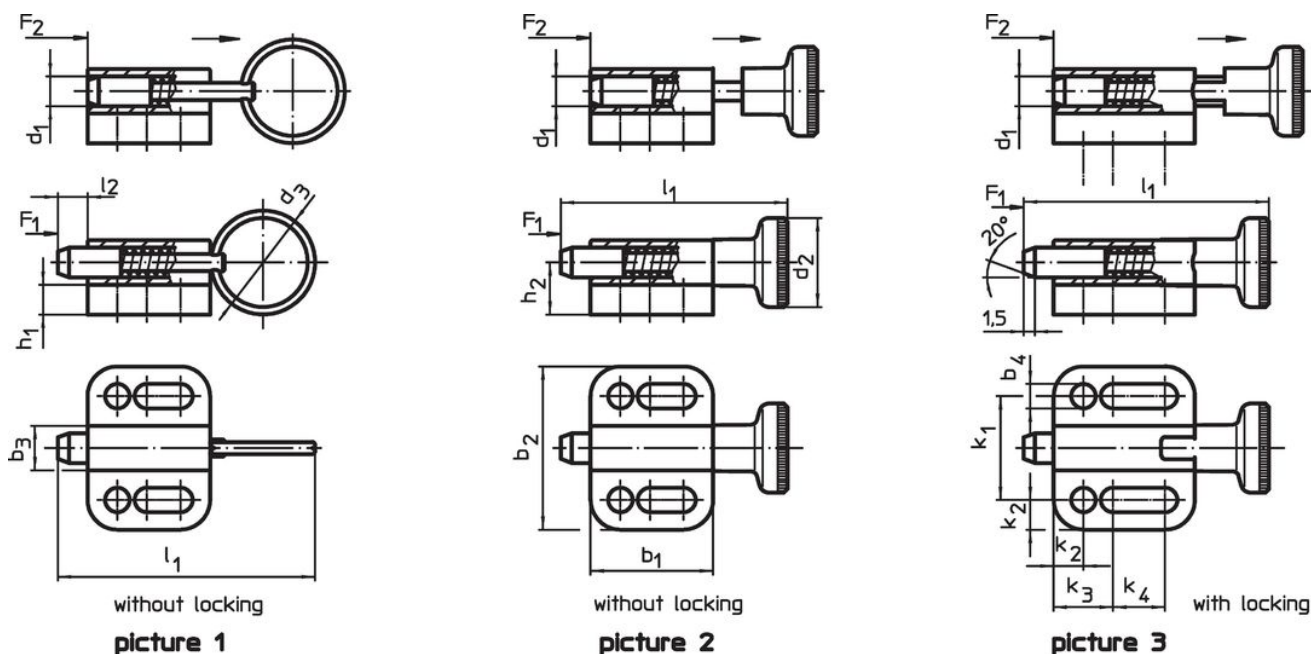

Order information

Dimensions														Spring load ¹⁾		max.	[g]	Art. No.				
d ₁	d ₃	b ₁	b ₂	b ₃	b ₄	h ₁	h ₂	k ₁	k ₂	k ₃	k ₄	l ₁	l ₂	F ₁	F ₂				[N]	[°C]	[g]	
h11					-0.2			±0.05					min.		~	~						
[mm]																						
with pull-ring, without locking – picture 1																						
5	18	22	28	8	4.3	4.5	9.5	18	5	10	7	45	5	5	24	100	21	22110.0305				

¹⁾ statistical average value

Application example

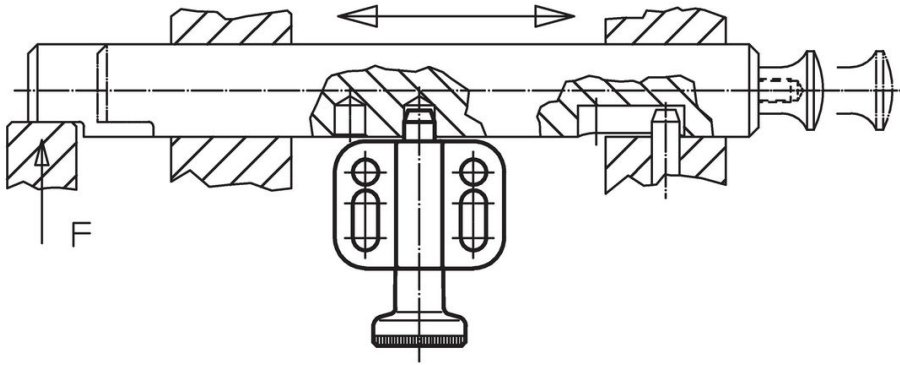

Compliance

RoHS compliant

Compliant according to Directive 2011/65/EU and Directive 2015/863.

Does not contain SVHC substances

No SVHC substances with more than 0.1% w/w contained - SVHC list [REACH] as of 23.01.2024.

Does not contain Proposition 65 substances

No Proposition 65 substances included.

<https://www.P65Warnings.ca.gov/>

Free from Conflict Minerals

This product does not contain any substances designated as "conflict minerals" such as tantalum, tin, gold or tungsten from the Democratic Republic of Congo or adjacent countries.