

## Index Plungers Compact • with hexagon collar

22110.0244



### Product Description

Index plungers are used for indexing bores.  
Types with / without lock have the same building height.  
Due to a thread recess the index plungers can be completely screwed in.

### Material

#### Body

- Stainless steel 1.4305

#### Locking pin

- Stainless steel 1.4305, nickel-plated

### Assembly

The screw length can be adapted by distance collars for index plungers (EH 22120.).

### More information

### Notes

Knob not removable.  
Lock nuts have to be purchased separately.

### Further products

- Mounting Blocks, for index bolts and index plungers, die-cast
- Locating Bushings, for index bolts and index plungers
- Distance Collars, for index plungers

### Drawing

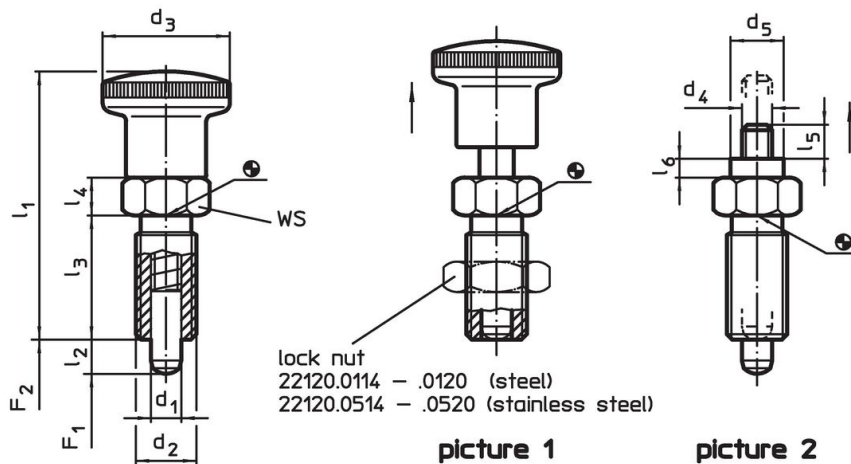

### Order information

Dimensions									WS [mm]	Spring load <sup>1)</sup>		max. [°C]	[g]	Art. No.
d <sub>1</sub> -0.02 -0.05	d <sub>2</sub>	l <sub>2</sub> min.	d <sub>4</sub>	d <sub>5</sub>	l <sub>3</sub>	l <sub>4</sub>	l <sub>5</sub>	l <sub>6</sub>		F <sub>1</sub> ~	F <sub>2</sub> ~			
[mm]									[mm]	[N]		[°C]	[g]	
<b>without knob – picture 2, Stainless steel</b>														
4	M8 x 1	6	M3	7	16	5	4.5	2.5	10	4	12.5	250	9	22110.0244

<sup>1)</sup> statistical average value

### Accessories

	Dimensions d <sub>2</sub> [mm]	Wrench size [mm]	[g]	Art. No.
<b>Lock nuts ISO 8675 (DIN 439), Stainless steel</b>				
	M 8 x 1	13	2.7	22120.0514

### Application example



### Compliance

#### RoHS compliant

Compliant according to Directive 2011/65/EU and Directive 2015/863.

#### Does not contain SVHC substances

No SVHC substances with more than 0.1% w/w contained - SVHC list [REACH] as of 23.01.2024.

#### Does not contain Proposition 65 substances

No Proposition 65 substances included.  
<https://www.P65Warnings.ca.gov/>

#### Free from Conflict Minerals

This product does not contain any substances designated as "conflict minerals" such as tantalum, tin, gold or tungsten from the Democratic Republic of Congo or adjacent countries.