

Index Plungers Mini Indexes

22110.0040



Product Description

Particularly suitable for screwing into thin walled pieces.
Performance in the smallest space requirements.

Material

Body

- Steel, zinc-plated by galvanization

Locking pin

- Stainless steel 1.4305

Knob

- Thermoplastic PA 6, black, dull

Assembly

Screw in the mini index. By lifting the knob, the hexagon will be released for assembly.
The screw length can be adapted by distance collars for index plungers (EH 22120.).

Operation

When using the self-locking type the knob is pulled-out, turned 30° and secured by a notched catch.

More information

Notes

Knob not removable.

Further products

- Distance Collars, for index plungers

Drawing

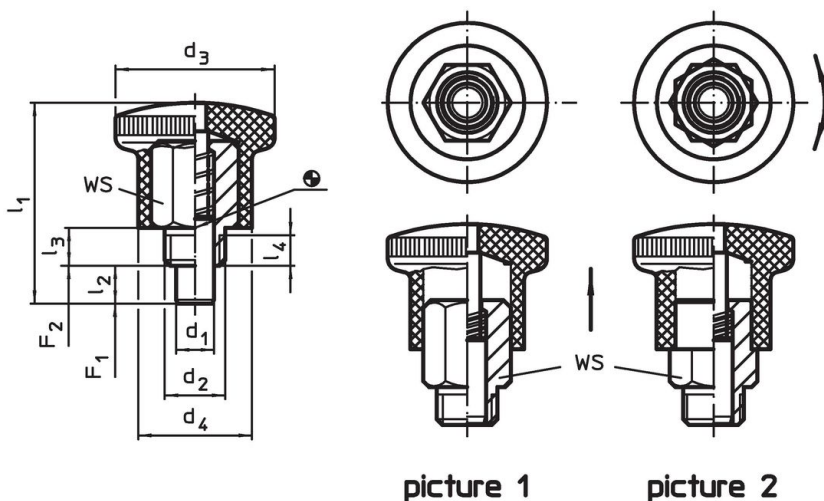

Order information

Dimensions								WS	Spring load ¹⁾		min. max.	[g]	Art. No.	
d ₁	d ₂	d ₃	d ₄	l ₁	l ₂ min.	l ₃	l ₄ min.		F ₁ ~	F ₂ ~				[°C]
0 -0.06								[mm]	[N]		[°C]	[g]		
with locking, knob black – picture 2, Steel														
7	M10 x 1	25	18	34	7	7	4.5	12	5	18	-30	80	25	22110.0040

¹⁾ statistical average value

Application example



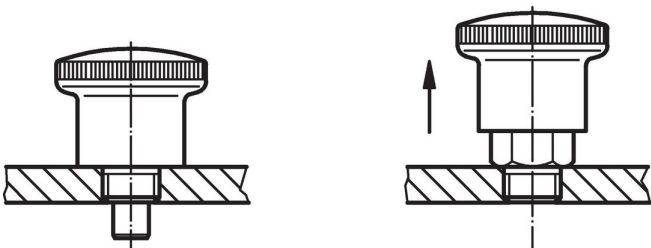

Compliance

RoHS compliant

Contains lead - compliant according to exceptions 6a / 6b / 6c.

Contains SVHC substances >0,1% w/w

Contains lead - SVHC list [REACH] as of 27.06.2024.

Contains Proposition 65 substances



Lead can cause cancer and reproductive harm from exposure
<https://www.P65Warnings.ca.gov/>

Free from Conflict Minerals

This product does not contain any substances designated as "conflict minerals" such as tantalum, tin, gold or tungsten from the Democratic Republic of Congo or adjacent countries.