

Spring Plungers · smooth, with collar and ball, self-clamping

22080.0806



Product Description

Spring plungers can be used for locating or for applying pressure, as a detent or for ejection. Due to expanding fit of the body, the spring plungers can accommodate variation of up to 0,2 mm in the locating bore. A less precise locating hole means lower machining costs.

Material

Body

- Thermoplastic POM, black

Ball

- Thermoplastic POM, white

Spring

- Stainless steel

Assembly

Thanks to the flexible design of the body, a direct manual mounting and a secure overhead installation is possible.

More information

Notes

Special types on request.
Spring plungers are specially tested for spring range and forces.

References

Calculation of indexing resistance, please refer to appendix - Technical Data -

Further products

- Spring Plungers, smooth, with collar and ball
- Locators, with bore hole, for spring plungers
- Locators, smooth, for spring plungers
- Spring Plungers, smooth, with collar and ball, self-clamping – INCH

Drawing

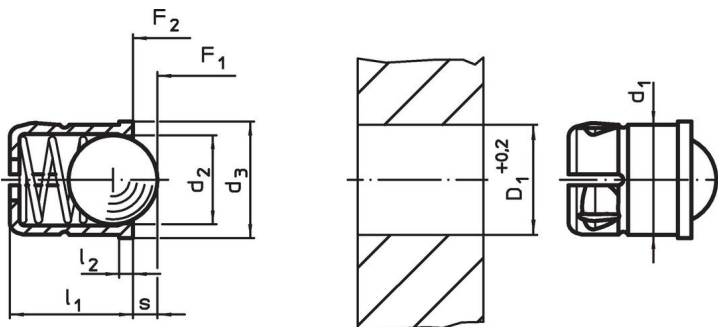

Order information

Dimensions					Stroke s [mm]	Spring load ¹⁾		Temperature		Location hole D ₁ +0.2 [mm]	Weight [g]	Art. No.
d ₁ +0.1	d ₂	d ₃	l ₁ ±0.2	l ₂ ~		F ₁ ~	F ₂ ~	min.	max.			
[mm]						[N]		[°C]				
body and ball from thermoplastic												
6	5	6.5	7	1	1.6	6.2	12.6	-30	50	6	0.2	22080.0806

¹⁾ statistical average value

Application example



Compliance

RoHS compliant

Compliant according to Directive 2011/65/EU and Directive 2015/863.

Does not contain SVHC substances

No SVHC substances with more than 0.1% w/w contained - SVHC list [REACH] as of 23.01.2024.

Does not contain Proposition 65 substances

No Proposition 65 substances included.

<https://www.P65Warnings.ca.gov/>

Free from Conflict Minerals

This product does not contain any substances designated as "conflict minerals" such as tantalum, tin, gold or tungsten from the Democratic Republic of Congo or adjacent countries.