

Spring Plungers • long version

22070.0260



Product Description

To be used for ejecting, as a detent, for applying pressure or as a shock element.

Material

- Pin**
 - Stainless Steel 1.4305, nitrided
- Body**
 - Stainless steel 1.4305
- Spring**
 - Stainless steel

Assembly

Spring plungers can be mounted and removed by means of the slot or internal hexagon. Please use a special assembly tool for mounting with a slot (pin side).

Characteristic

Standard spring load: no marking



More information

Notes

Special types on request.
Spring plungers are specially tested for spring range and forces.

References

Thread lock: polyamide all-around coating (for details please refer to the technical appendix).

Drawing

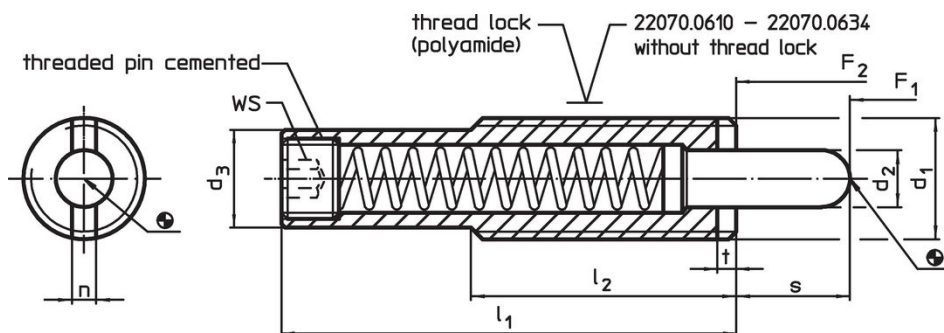

Order information

Dimensions								Stroke s [mm]	WS [mm]	Spring load ¹⁾		Temperature		Weight [g]	Art. No.
d ₁	d ₂	d ₃	l ₁	l ₂	n	t	F ₁ [N]			F ₂ [N]	min. [°C]	max. [°C]			
stainless steel, standard spring load, with thread lock															
M16	8	13.4	148	35	3.2	3	50	6	7	43	-30	90	119	22070.0260	

¹⁾ statistical average value

Application example



Compliance

RoHS compliant

Compliant according to Directive 2011/65/EU and Directive 2015/863.

Does not contain SVHC substances

No SVHC substances with more than 0.1% w/w contained - SVHC list [REACH] as of 23.01.2024.

Does not contain Proposition 65 substances

No Proposition 65 substances included.

<https://www.P65Warnings.ca.gov/>

Free from Conflict Minerals

This product does not contain any substances designated as "conflict minerals" such as tantalum, tin, gold or tungsten from the Democratic Republic of Congo or adjacent countries.