

Base Plates · with positioning holes

1912.520



Product Description

Material

- Grey cast iron GG

More information

Notes

Special plates on request.

Drawing

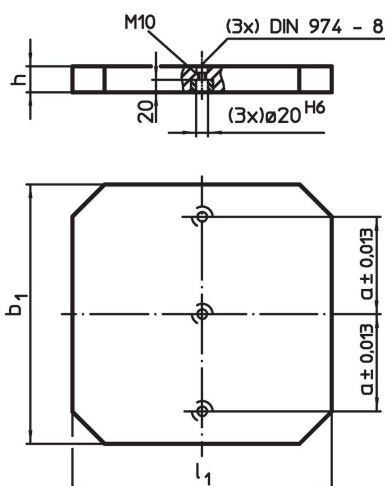

Order information

$b_1 \times l_1$	Dimensions				Art. No.
	[mm]	h ± 0.03	a ± 0.013		
500 x 630		50	200	112	1912.520

Application example

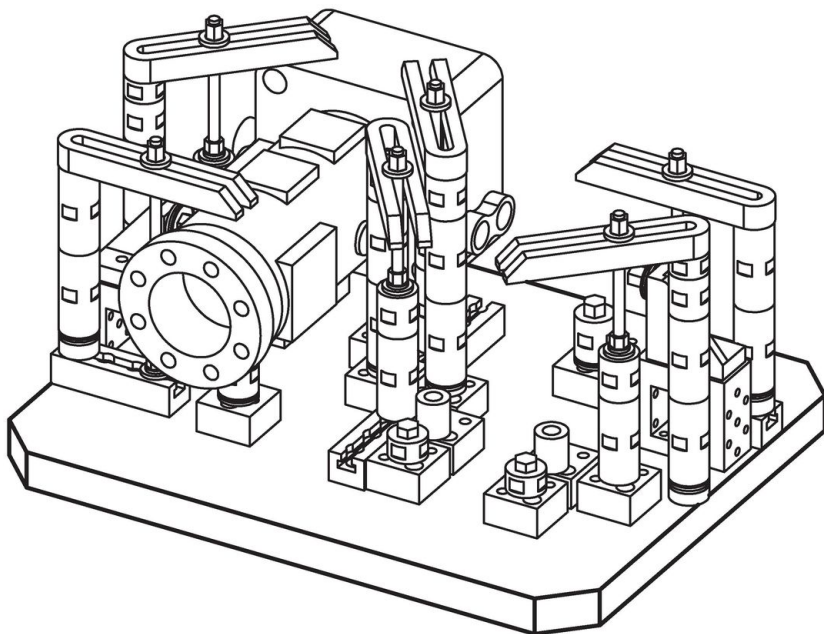

Compliance

RoHS compliant

Compliant according to Directive 2011/65/EU and Directive 2015/863.

Does not contain SVHC substances

No SVHC substances with more than 0.1% w/w contained - SVHC list [REACH] as of 23.01.2024.

Does not contain Proposition 65 substances

No Proposition 65 substances included.

<https://www.P65Warnings.ca.gov/>

Free from Conflict Minerals

This product does not contain any substances designated as "conflict minerals" such as tantalum, tin, gold or tungsten from the Democratic Republic of Congo or adjacent countries.