

Clamping Angles • one-sided, welded, semi-finished

1910.040



Product Description

Material

- Steel, welded

More information

Notes

Special plates on request.

Drawing

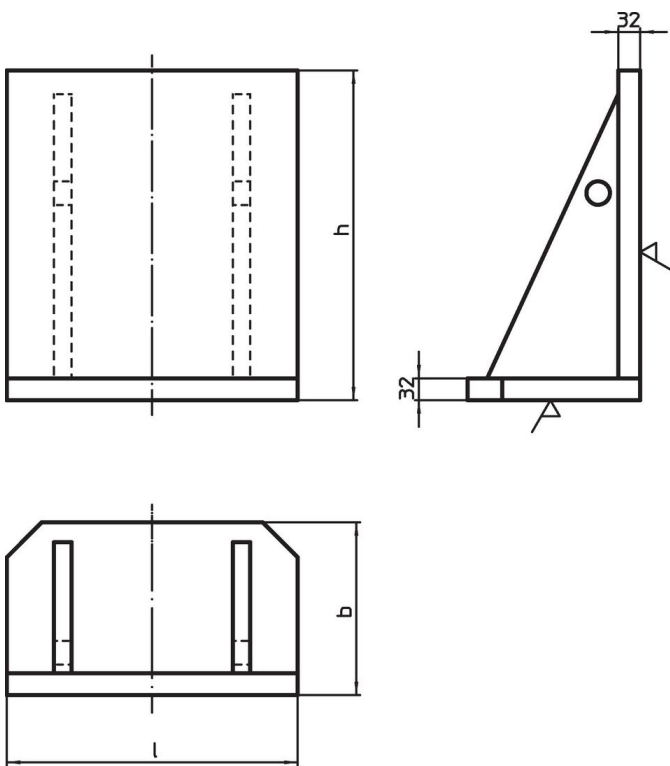

Order information

l	Dimensions		[kg]	Art. No.
	b [mm]	h		
500	330	550	125	1910.040

Application example

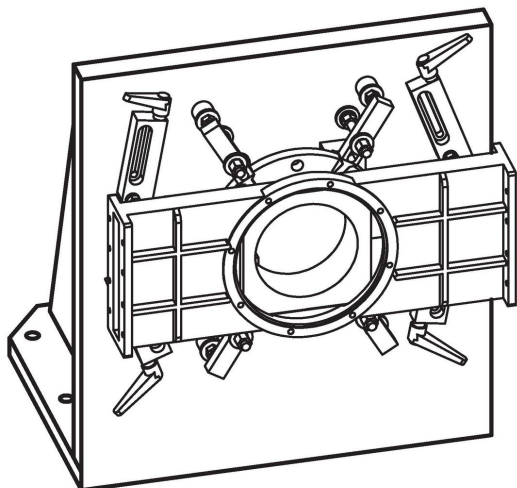

Compliance

RoHS compliant

Compliant according to Directive 2011/65/EU and Directive 2015/863.

Does not contain SVHC substances

No SVHC substances with more than 0.1% w/w contained - SVHC list [REACH] as of 23.01.2024.

Does not contain Proposition 65 substances

No Proposition 65 substances included.

<https://www.P65Warnings.ca.gov/>

Free from Conflict Minerals

This product does not contain any substances designated as "conflict minerals" such as tantalum, tin, gold or tungsten from the Democratic Republic of Congo or adjacent countries.