

Master Jaw Adapters

1701.140

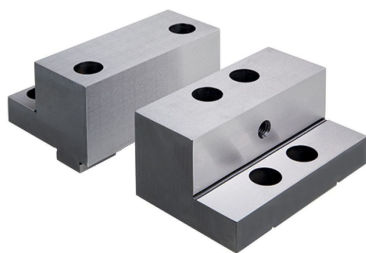

Product Description

- High side of the jaw is hardened
- Additional thread for mounting the interchangeable jaws (Art. No. 1701.250 - 1701.280)
- Ground clamping surfaces
- Mountings for click system (Art. No. 1701.190 -1701.200) on the high side of the jaw

Material

- Steel

Drawing

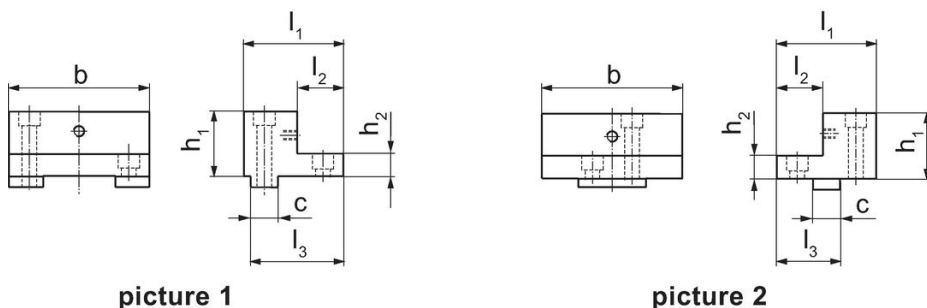

picture 1

picture 2

Order information

Jaw width [mm]	Dimensions							[kg]	Art. No.
	b	l ₁	l ₂	l ₃	h ₁	h ₂	c		
Jaw, fixed – picture 1									
125	126	85	32	77	58	20	24	4	1701.140

Application example

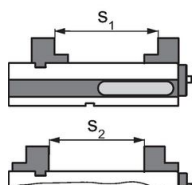

	MS 125-S	MS 125-M	MS 125-L
Clamping width s ₁	66 - 126	71 - 243	66 - 376
Clamping width s ₂	0 - 107	47 - 224	0 - 357

Compliance

RoHS compliant

Compliant according to Directive 2011/65/EU and Directive 2015/863.

Does not contain SVHC substances

No SVHC substances with more than 0.1% w/w contained - SVHC list [REACH] as of 23.01.2024.

Does not contain Proposition 65 substances

No Proposition 65 substances included.

<https://www.P65Warnings.ca.gov/>

Free from Conflict Minerals

This product does not contain any substances designated as "conflict minerals" such as tantalum, tin, gold or tungsten from the Democratic Republic of Congo or adjacent countries.