

Insertion Tools

1586.260



Product Description

Keeps the workpiece in position during the clamping process.

Material

- Steel, blackened

Assembly

The supports (Art. No. 1586.200, 1586.201 and 1586.202) are required.

More information

Notes

Spring load of 100 N per lateral spring plunger.

Drawing

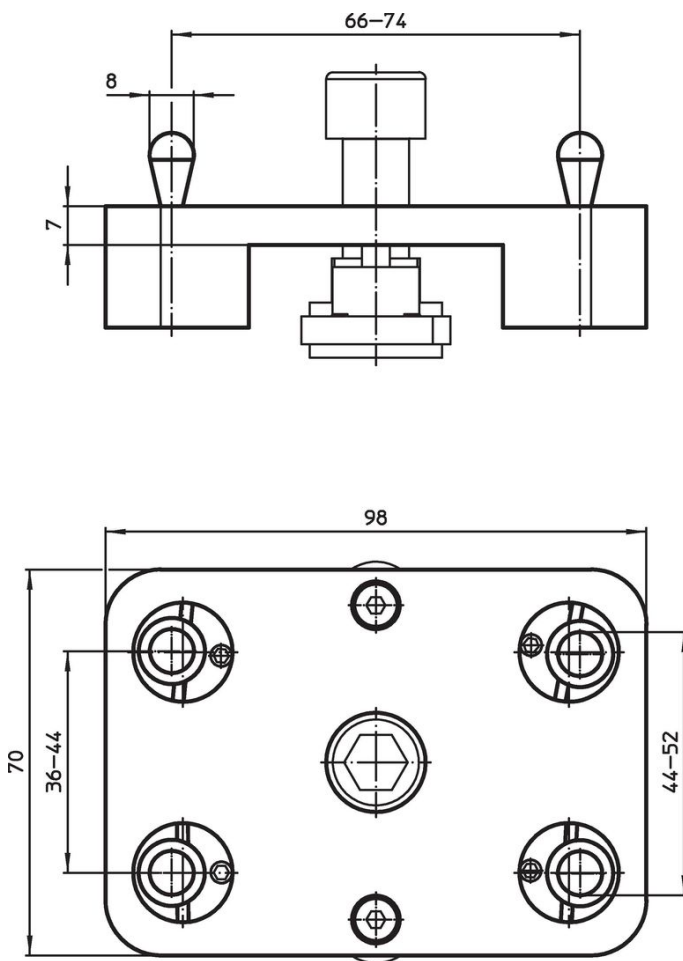

Order information

	Art. No.
 [g] 800	1586.260

Compliance

RoHS compliant

Compliant according to Directive 2011/65/EU and Directive 2015/863.

Does not contain SVHC substances

No SVHC substances with more than 0.1% w/w contained - SVHC list [REACH] as of 23.01.2024.

Does not contain Proposition 65 substances

No Proposition 65 substances included.

<https://www.P65Warnings.ca.gov/>

Free from Conflict Minerals

This product does not contain any substances designated as "conflict minerals" such as tantalum, tin, gold or tungsten from the Democratic Republic of Congo or adjacent countries.