

Lateral Stops

1586.252



Product Description

Material

- Steel

Assembly

The stop can be mounted on both sides of the clamping bar.

Magnetic version - picture 2:

The stop can be quickly and easily removed before machining the workpiece due to the tool-free mounting.

Drawing

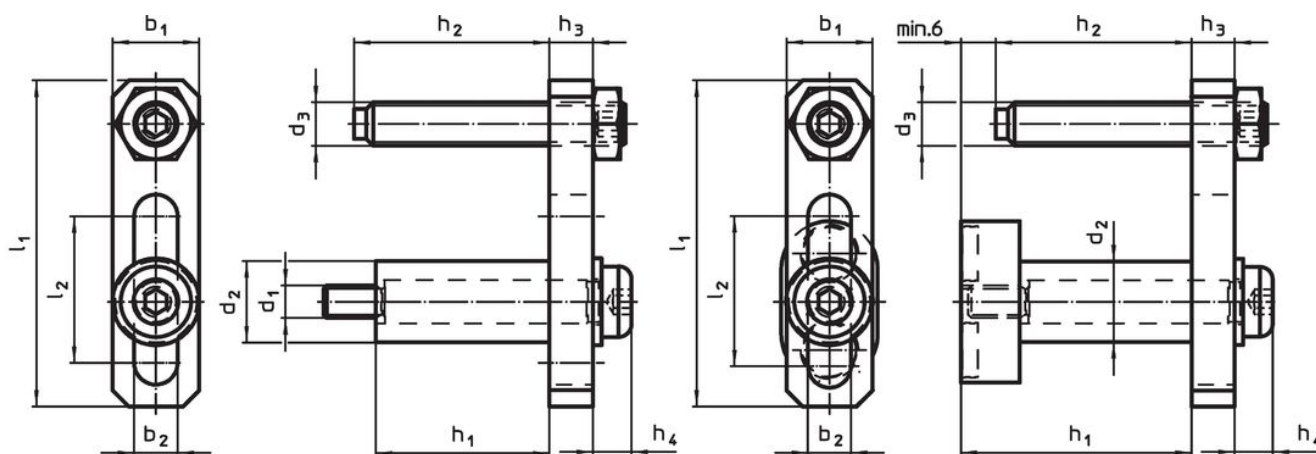

picture 1

picture 2

Order information

Dimensions										[g]	Art. No.
d ₂	d ₃	l ₁	l ₂	b ₁	b ₂	h ₁	h ₂	h ₃	h ₄		
picture 2											
15	M8	60	27	16	8	43	0 - 37	8	7	151	1586.252

Compliance

RoHS compliant

Compliant according to Directive 2011/65/EU and Directive 2015/863.

Does not contain SVHC substances

No SVHC substances with more than 0.1% w/w contained - SVHC list [REACH] as of 27.06.2024.

Does not contain Proposition 65 substances

No Proposition 65 substances included.

<https://www.P65Warnings.ca.gov/>

Free from Conflict Minerals

This product does not contain any substances designated as "conflict minerals" such as tantalum, tin, gold or tungsten from the Democratic Republic of Congo or adjacent countries.