

V-Blocks  
1548.100

Product Description

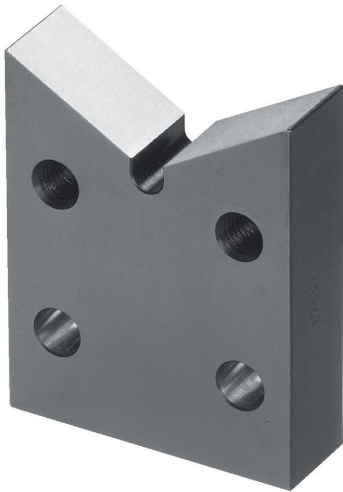

Material

- Steel, case-hardened, ground

Drawing

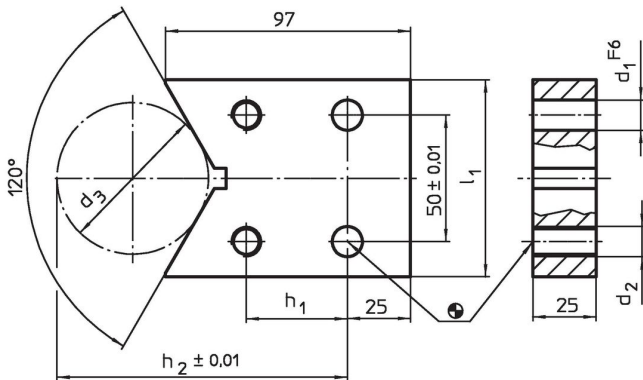

Order information

System	Dimensions								[g]	Art. No.
	$l_1$	$h_1$	$h_2$	$d_1$	$d_2$	$d_3$	$d_3$ min.	$d_3$ max.		
L12	78	40	115	12	M12	60	18	148	1249	1548.100

## Application example

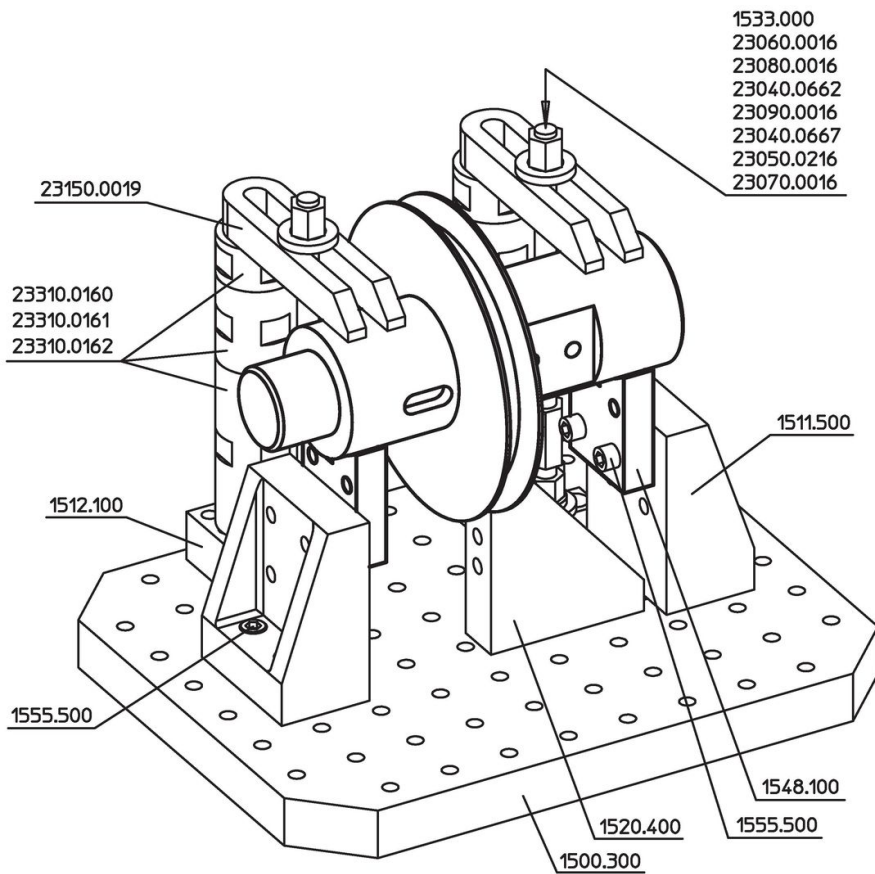

## Compliance

### RoHS compliant

Compliant according to Directive 2011/65/EU and Directive 2015/863.

### Does not contain SVHC substances

No SVHC substances with more than 0.1% w/w contained - SVHC list [REACH] as of 27.06.2024.

### Does not contain Proposition 65 substances

No Proposition 65 substances included.

<https://www.P65Warnings.ca.gov/>

### Free from Conflict Minerals

This product does not contain any substances designated as "conflict minerals" such as tantalum, tin, gold or tungsten from the Democratic Republic of Congo or adjacent countries.