

V-Blocks

1148.000



Product Description

Material

- Steel, case-hardened, ground

Drawing

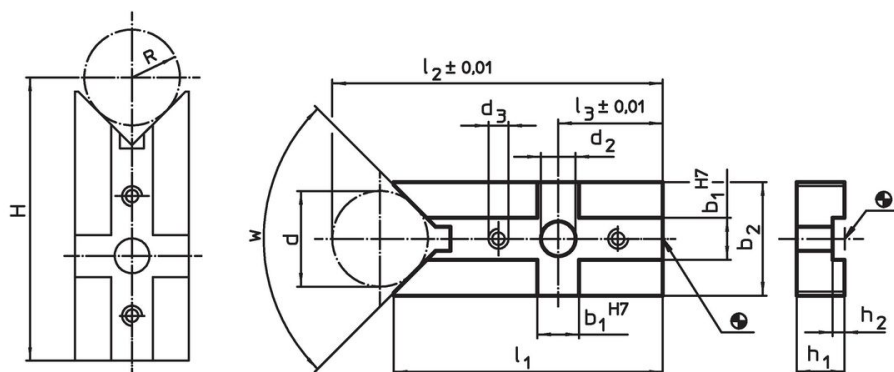

$H = (R*1,414) + 49,497$	[1048.200]
$H = (R*1,414) + 48,996$	[1048.300]
$H = (R*1,155) + 77,025$	[1148.000]
$H = (R*1,155) + 81,204$	[1148.100]
$H = (R*1,414) + 72,872$	[1148.200]
$H = (R*1,414) + 73,159$	[1148.300]

Order information

System	Dimensions												w	[g]	Art. No.
	b ₁	d	b ₂	d ₂	d ₃	l ₁	l ₂	l ₃	h ₁	h ₂	d min.	d max.			
V70	14	32	38	13	M6	87	111.5	35	16	4	18	66	120°	331	1148.000

Application example

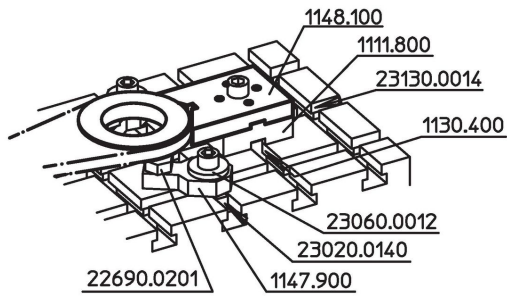

Compliance

RoHS compliant

Compliant according to Directive 2011/65/EU and Directive 2015/863.

Does not contain SVHC substances

No SVHC substances with more than 0.1% w/w contained - SVHC list [REACH] as of 23.01.2024.

Does not contain Proposition 65 substances

No Proposition 65 substances included.
<https://www.P65Warnings.ca.gov/>

Free from Conflict Minerals

This product does not contain any substances designated as "conflict minerals" such as tantalum, tin, gold or tungsten from the Democratic Republic of Congo or adjacent countries.