

Base Plates • suitable on pallets DIN 55 201

1103.300



Product Description

Material

- Steel, hardened, ground

More information

Notes

Special types on request.

Drawing

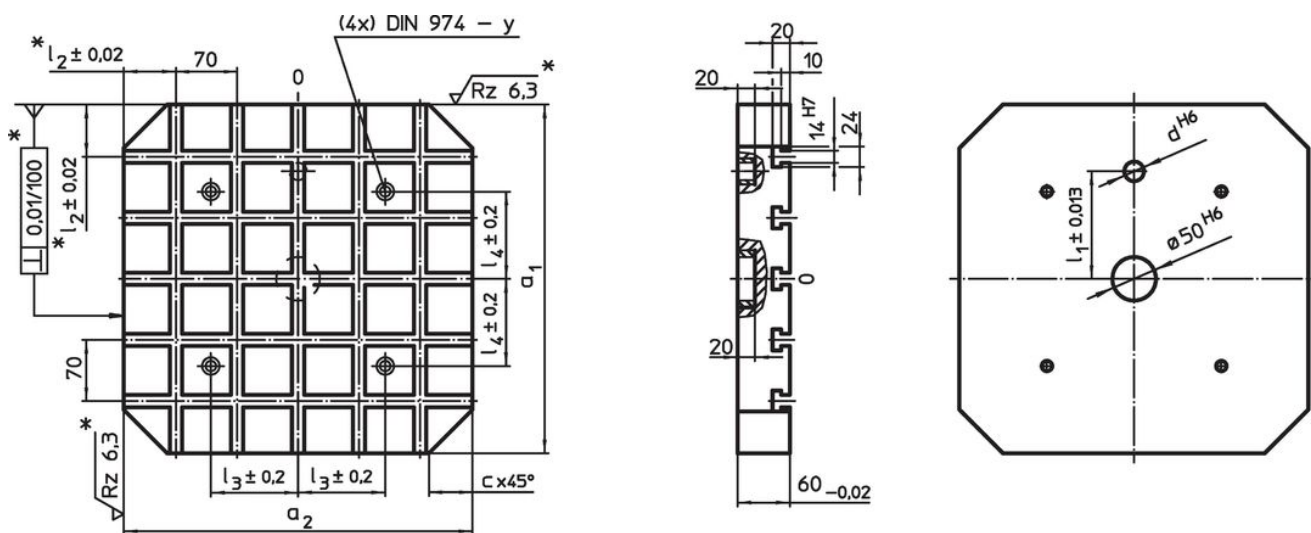

\* These tolerances are valid only for optional exterior stop type.  
Slot spacing  $70 \pm 0,01$ .

Order information

System	Dimensions							For screws	y	Number of T-slots	[kg]	Art. No.
	$a_1 \times a_2$	c	d	$l_1$ $\pm 0,013$ [mm]	$l_2$	$l_3$	$l_4$					
V70	400 x 500	50	20	150	60/40	200	100	M12	12	5 x 7	69	1103.300

Application example









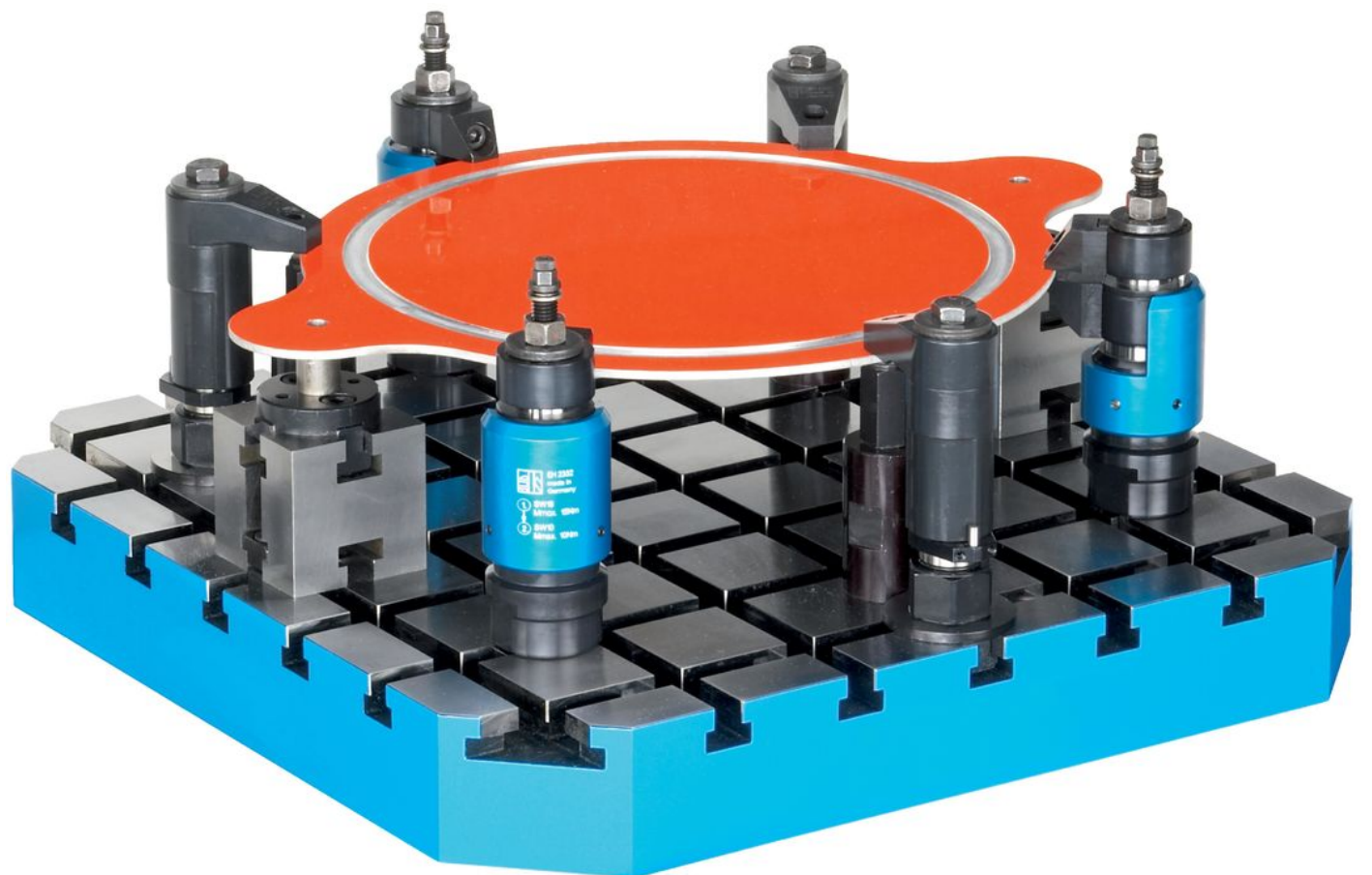

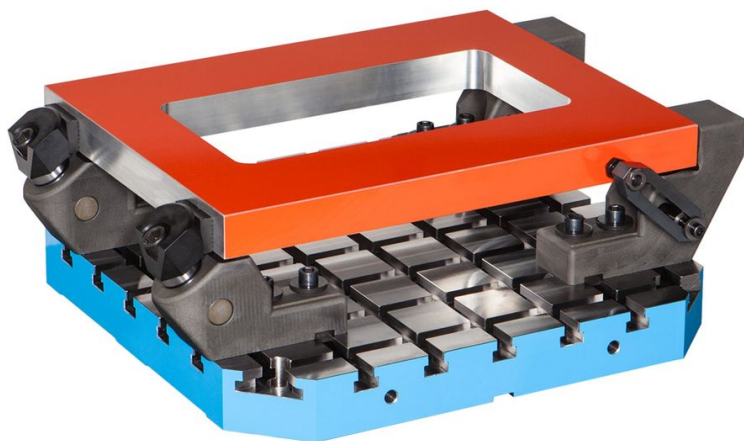

## Compliance

### RoHS compliant

Compliant according to Directive 2011/65/EU and Directive 2015/863.

### Does not contain SVHC substances

No SVHC substances with more than 0.1% w/w contained - SVHC list [REACH] as of 27.06.2024.

### Does not contain Proposition 65 substances

No Proposition 65 substances included.

<https://www.P65Warnings.ca.gov/>

### Free from Conflict Minerals

This product does not contain any substances designated as "conflict minerals" such as tantalum, tin, gold or tungsten from the Democratic Republic of Congo or adjacent countries.